



For more Hi-Fi manuals and set-up information
please visit www.hifiengine.com

STEREO POWER AMPLIFIER

MX-630

SERVICE MANUAL

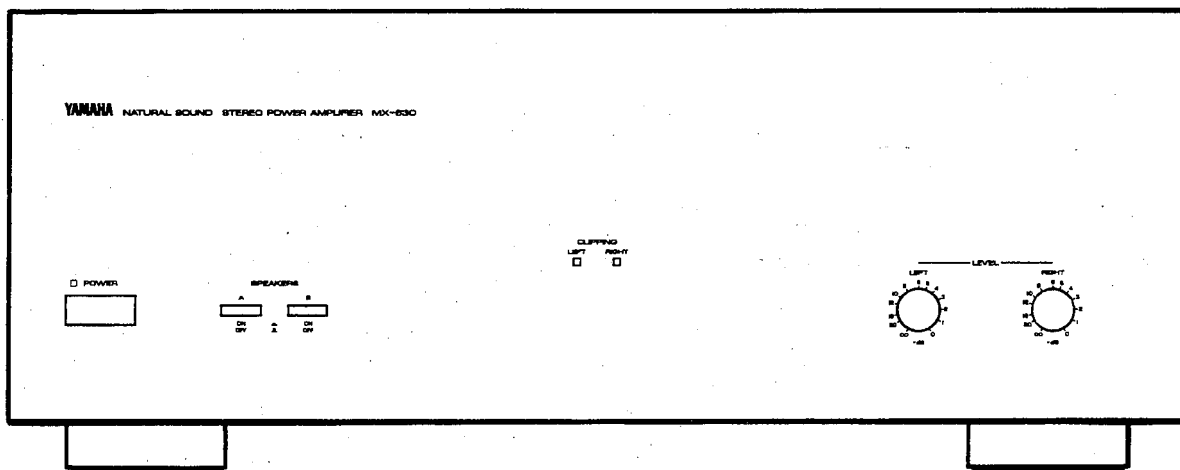

IMPORTANT NOTICE

This manual has been provided for the use of authorized Yamaha Retailers and their service personnel. It has been assumed that basic service procedures inherent to the industry, and more specifically Yamaha Products, are already known and understood by the users, and have therefore not been restated.

WARNING: Failure to follow appropriate service and safety procedures when servicing this product may result in personal injury, destruction of expensive components and failure of the product to perform as specified. For these reasons, we advise all Yamaha product owners that all service required should be performed by an authorized Yamaha Retailer or the appointed service representative.

IMPORTANT: The presentation or sale of this manual to any individual or firm does not constitute authorization, certification or recognition of any applicable technical capabilities, or establish a principle-agent relationship of any form.

The data provided is believed to be accurate and applicable to the unit(s) indicated on the cover. The research, engineering, and service departments of Yamaha are continually striving to improve Yamaha products. Modifications are, therefore, inevitable and specifications are subject to change without notice or obligation to retrofit. Should any discrepancy appear to exist, please contact the distributor's Service Division.

WARNING: Static discharges can destroy expensive components. Discharge any static electricity your body may have accumulated by grounding yourself to the ground buss in the unit (heavy gauge black wires connect to this buss).

IMPORTANT: Turn the unit OFF during disassembly and parts replacement. Recheck all work before you apply power to the unit.

CONTENTS

TO SERVICE PERSONNEL	1
SPECIFICATIONS	1
REAR PANELS	2
BLOCK DIAGRAM	3
INTERNAL VIEW	3
DISASSEMBLY PROCEDURES	4

ADJUSTMENTS	4
WIRING	5
PRINTED CIRCUIT BOARD	6-9
SCHEMATIC DIAGRAM	10
PARTS LIST	11-17

100337

YAMAHA

YAMAHA CORPORATION
P.O. Box 1, Hamamatsu, Japan

3.3K-081 © Printed in Japan. '90.2

MX-630

TO SERVICE PERSONNEL

- Critical Components Information.**
Components having special characteristics are marked Δ and must be replaced with parts having specifications equal to those originally installed.
- Leakage Current Measurement (For 120V Model Only).**
When service has been completed, it is imperative that you verify that all exposed conductive surfaces are properly insulated from supply circuits.
 - Meter impedance should be equivalent to 1500 ohm shunted by 0.15 μ F.
 - Leakage current must not exceed 0.5mA.
 - Be sure to test for leakage with the AC plug in both polarities.

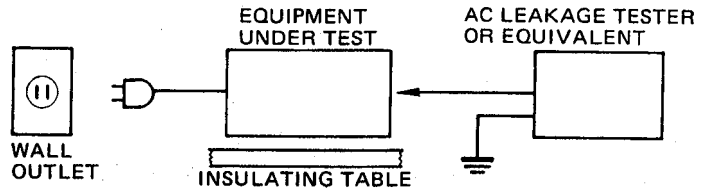

POLARIZATION (U, C models only)

This amplifier product is equipped with a polarized alternating current line plug (a plug having one blade wider than the other). This plug will fit into the power outlet only one way. This is a safety feature.

SPECIFICATIONS

Minimum RMS Output Power per Channel (20 Hz - 20 kHz)

0.003% THD, 8 ohms	
U.S.A. and Canada models	135W
Europe, U.K., Australia and General models	125W
0.007% THD, 6 ohms	
U.S.A. and Canada models	160W
Europe, U.K., Australia and General models	150W
0.02% THD, 4 ohms	
(U.S.A., Canada, Australia and General models only)	190W

Dynamic Power per Channel

(by IHF Dynamic Headroom measuring method)	
8 ohms	U.S.A. and Canada models 220W
	Europe, U.K., Australia and General models 175W
6 ohms	U.S.A. and Canada models 265W
	Europe, U.K., Australia and General models 220W
4 ohms	U.S.A. and Canada models 360W
	Europe, U.K., Australia and General models 290W
2 ohms	U.S.A. and Canada models 480W
	Europe, U.K., Australia and General models 390W

DIN Standard Output Power per Channel (Europe model only)

1 kHz, 1% THD, 4 ohms	215 W
-----------------------	-------

Dynamic Headroom (U.S.A. and Canada models only)

8 ohms	2.12 dB
6 ohms	2.19 dB
4 ohms	2.78 dB

IEC Power (Europe model only)

1 kHz, 1% THD	
8 ohms	140 W
6 ohms	170 W

Power Band Width

0.03% THD, 62.5W/8 ohms	10 Hz - 60 kHz
-------------------------	----------------

Damping Factor (1 kHz, 8 ohms)

	70
--	----

Input Sensitivity/Input Impedance

MAIN IN	1.14V/60 k-ohms
---------	-----------------

Frequency Response (20 Hz - 20 kHz)

MAIN IN	+0/-0.2 dB
---------	------------

Total Harmonic Distortion (20 Hz - 20 kHz)

MAIN IN to Sp Out, 62.5W/8 ohms	0.003%
---------------------------------	--------

Intermodulation Distortion

Rated Output/8 ohms	0.003%
---------------------	--------

Signal-to-Noise Ratio (IHF-A-Network)

MAIN IN (shorted)	123 dB
MAIN IN (5.1 k-ohms terminated)	119 dB

Residual Noise (IHF-A-Network)

	16 μ V
--	------------

Channel Separation (Input shorted, terminated, 1 kHz/10 kHz)

	89/70 dB
--	----------

Power Supply

Europe model	AC 220V, 50 Hz
General model	AC 110/120/220/240V, 50/60 Hz
U.K. and Australia models	AC 240V, 50 Hz
U.S.A. and Canada models	AC 120V, 60 Hz

Power Consumption

General model	500W
U.S.A. and Canada models	650W 800 VA
Europe, U.K. and Australia models	650W

AC Outlet (U.S.A., Canada and General models only)

UNSWITCHED x 1	200W max.
----------------	-----------

Dimensions (W x H x D)

	435x170x418.5 mm (17-1/8" x 6-1/2" x 16-17/32")
--	-------------------------------------------------

Weight

	13 kg (28 lbs. 10 oz.)
--	------------------------

- (U) U.S.A model
- (C) Canadian model
- (G) European model
- (A) Australian model
- (B) British model
- (R) General model

Dimensions

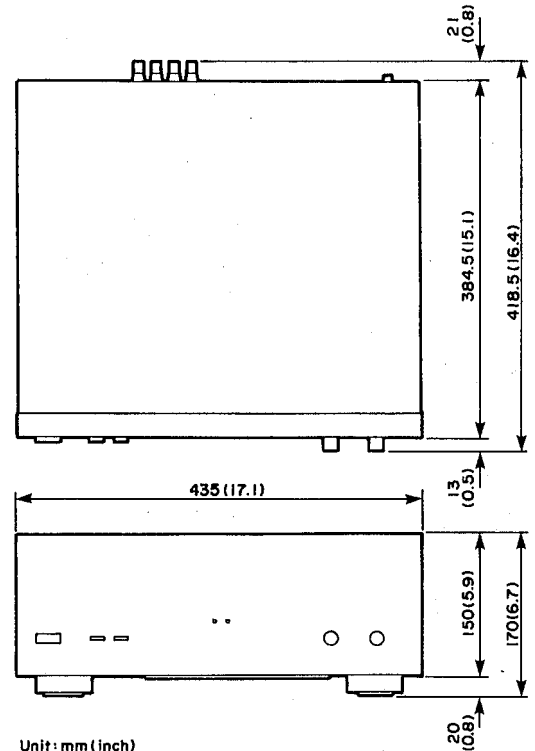

Unit: mm (inch)

* Please note that the design and all specifications are subject to change without notice.

REAR PANELS

U.S.A. & Canadian models

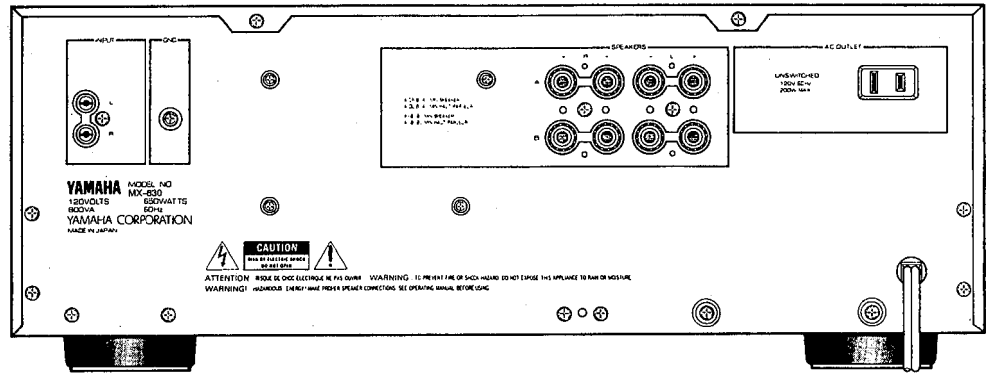

British & European models

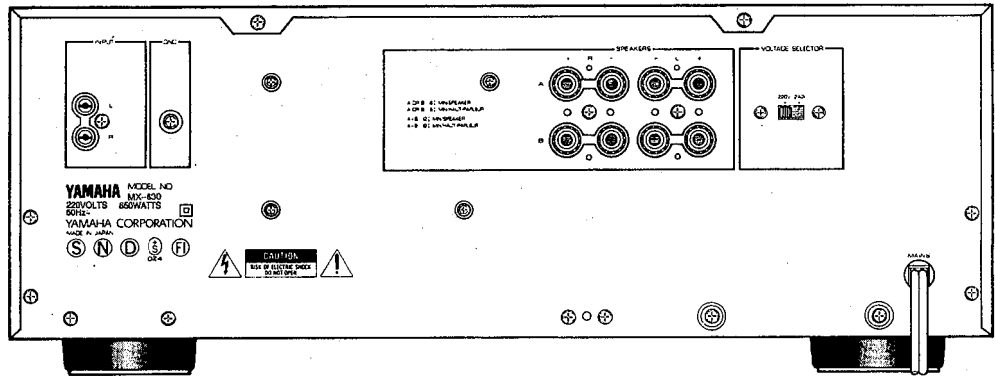

Australian model

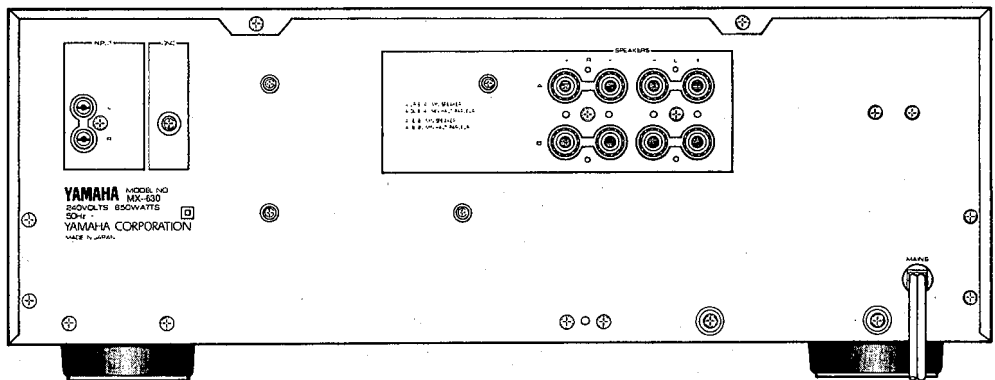

General model

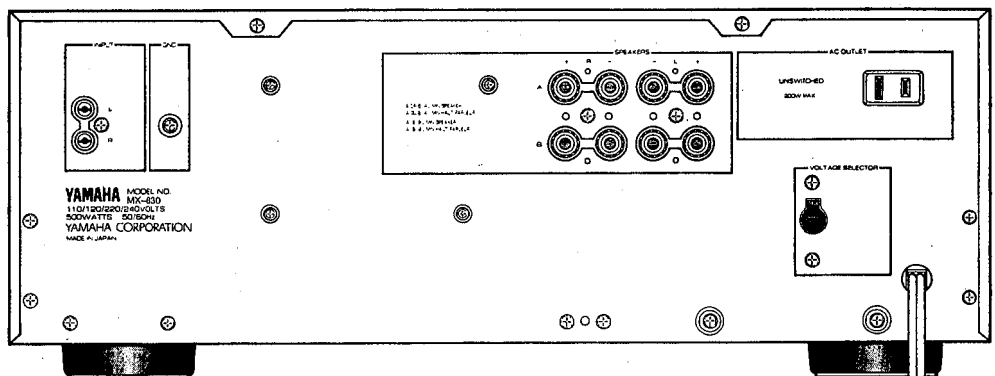

MX-630

BLOCK DIAGRAM

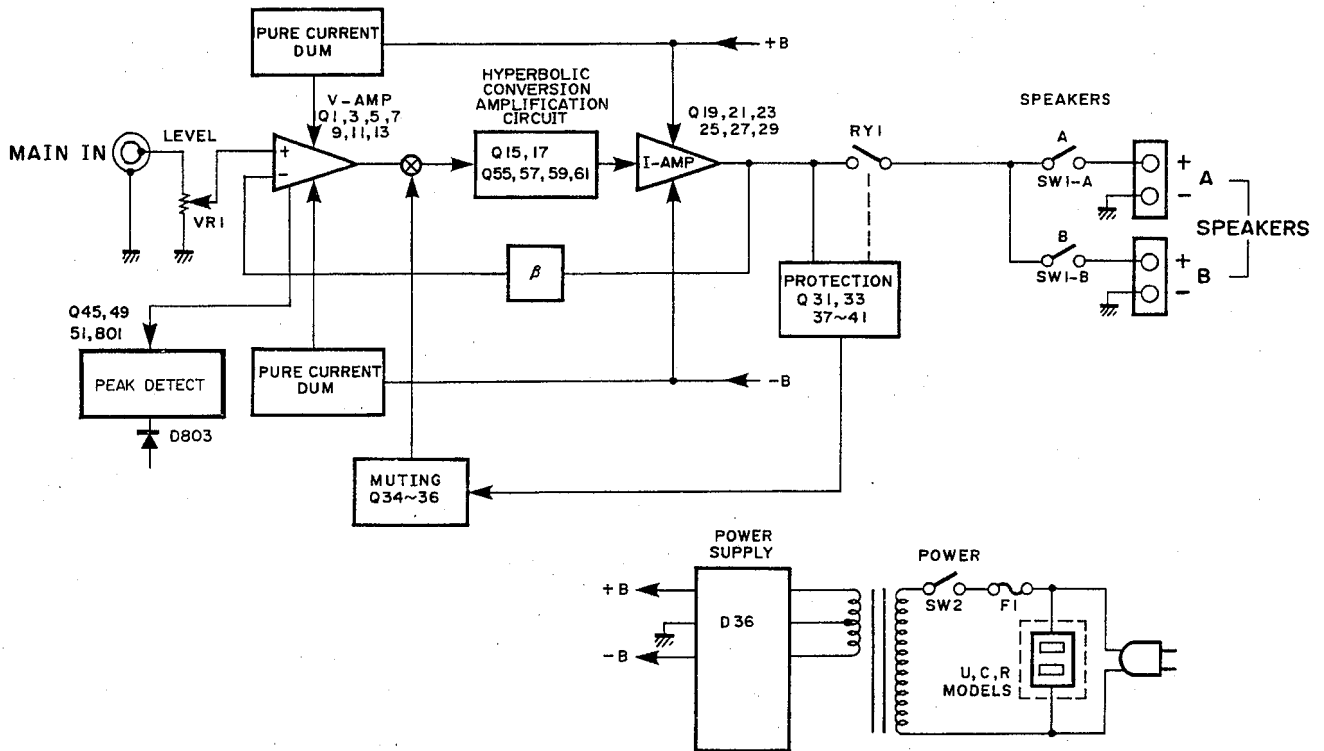

INTERNAL VIEW

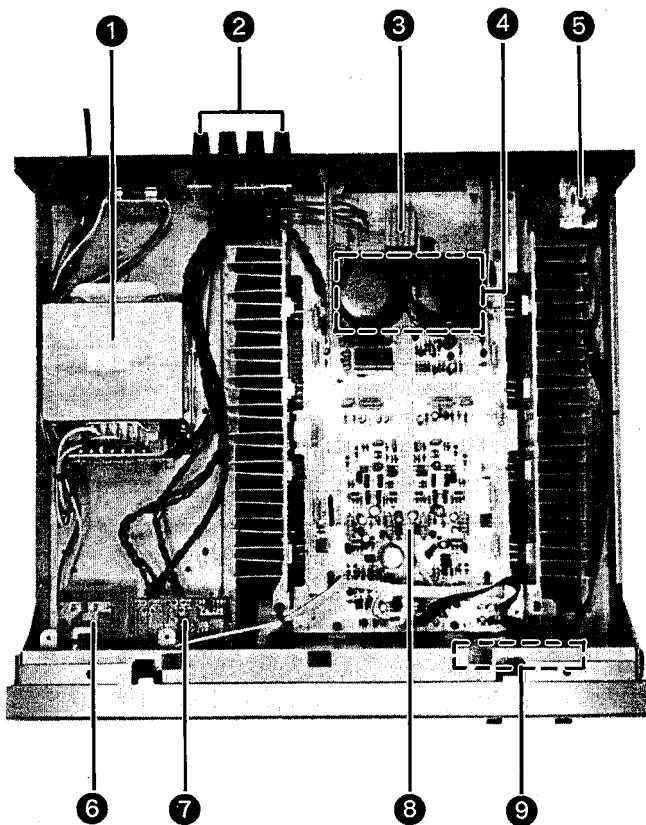

- 1** POWER TRANSFORMER
 U model : XE217A00
 C model : XE218A00
 R model : XE219A00
 A model : XE220A00
 B-G models : XE221A00
- 2** SPEAKER TERMINAL
- 3** DIODE BRIDGE : 4D4B41
- 4** ELECTROLYTIC CAP.
- 5** MAIN CIRCUIT BOARD(1)
- 6** LED CIRCUIT BOARD(3)
- 7** MAIN CIRCUIT BOARD(4)
- 8** MAIN CIRCUIT BOARD(3)
- 9** MAIN CIRCUIT BOARD(2)

DISASSEMBLY PROCEDURES

1. Removal of Top Cover

Remove 6 screws (①) in Fig. 1. and slide the Top Cover back.

2. Removal of Bottom Cover

Remove 6 screws (②) in Fig. 1.

3. Removal of Front Panel

Remove 5 screws (③) in Fig. 1.

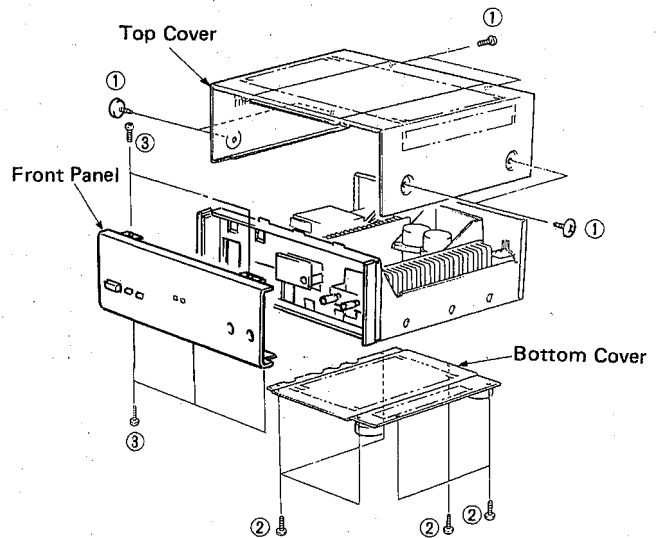

Fig. 1

ADJUSTMENTS

● IDLING CURRENT ADJUSTMENT

Wait 2 minutes after power ON to stabilize amplifier operation without signal.

Adjust VR3 (LcH) and VR4 (RcH) so that the voltage across the terminals of R87 (either R89, R91, R93) and R88 (either R90, R92, R94) come to $10\text{mV} \pm 2\text{mV DC}$.

	Test Points	Adjustment Points	Rating
LcH	Across the terminals of R87	VR 3	$10\text{mV} \pm 2\text{mV DC}$
RcH	Across the terminals of R88	VR 4	

● TEST POINTS

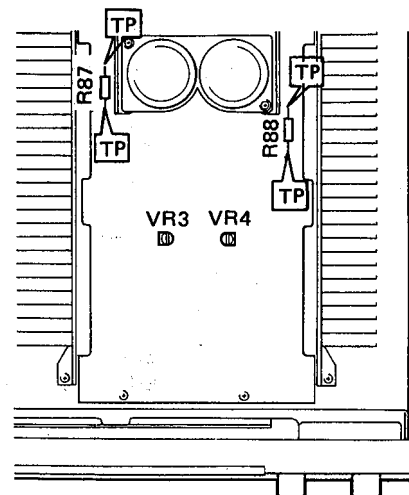

TOP VIEW

■ WIRING

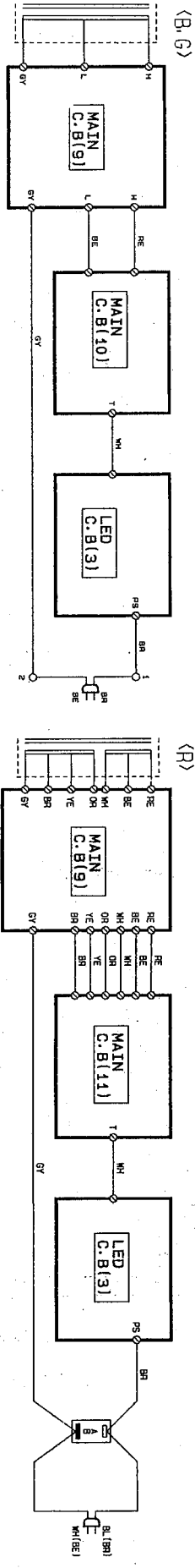
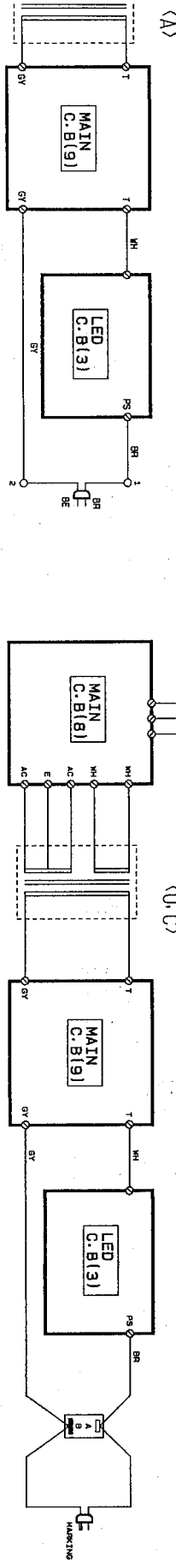
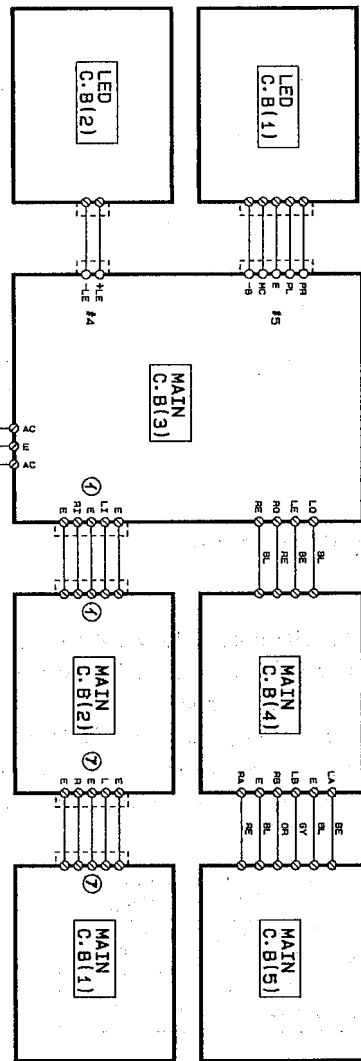

(U, C)

PRINTED CIRCUIT BOARD(Pattern side)

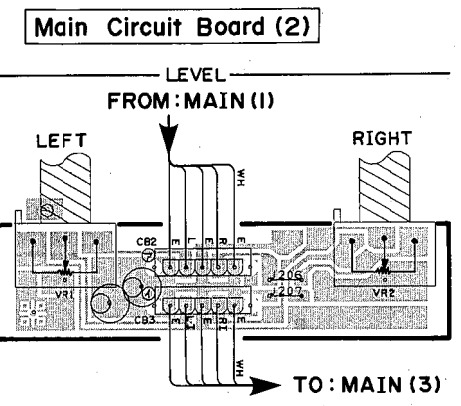
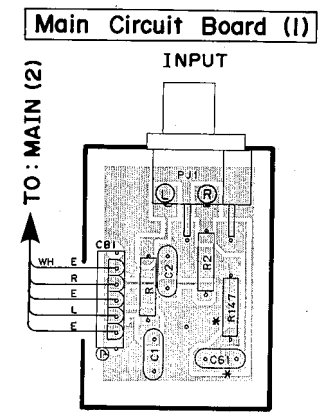
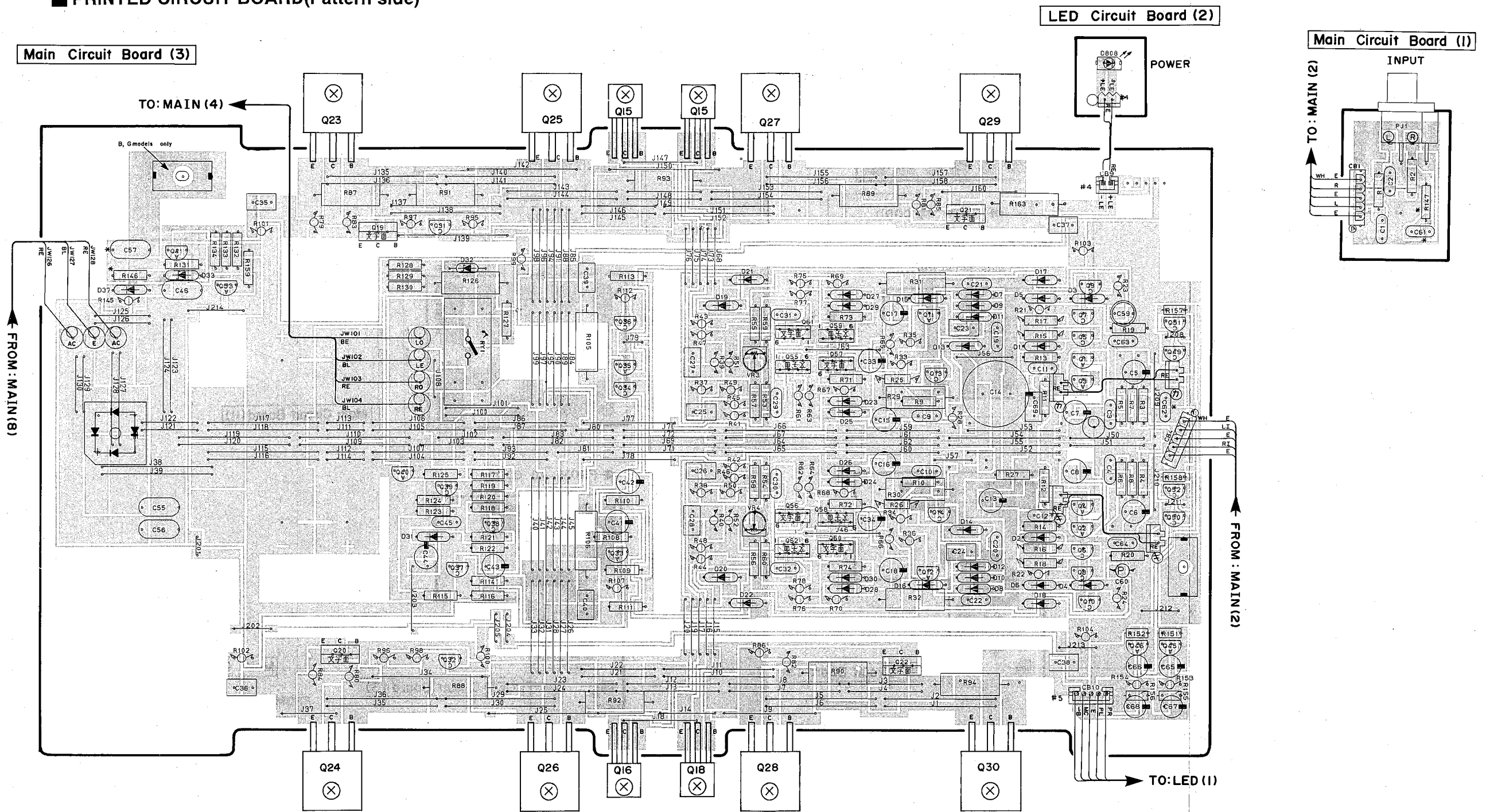

Notes) X marked

	U, C, R, A	G.B
C47~50	OPEN	0.01/100
C51,52,61	OPEN	0.01
C57	OPEN	0.1/250
C62,71,72	OPEN	100P/1000
C73,74	OPEN	100P
C75	OPEN	0.1
R143,144,146,147	OPEN	10
R164	OPEN	2.2

• U, C, A models

Main Circuit Board (9)

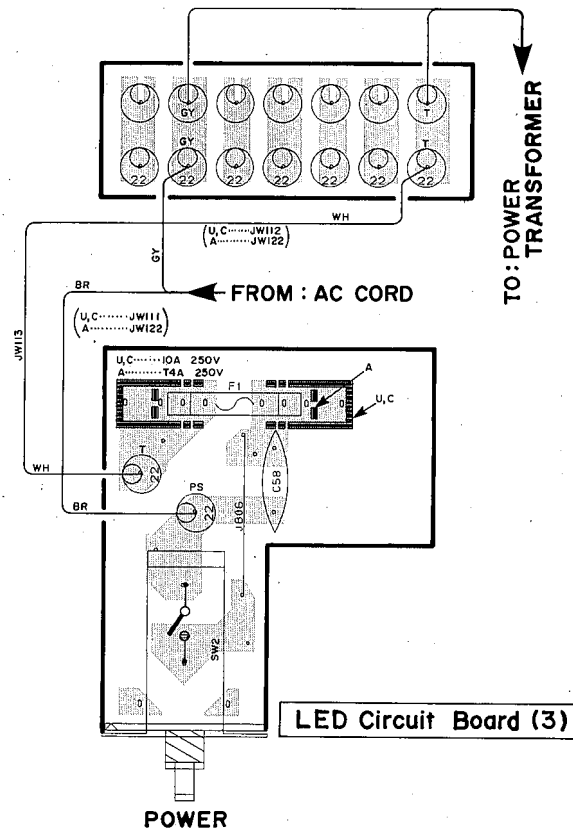

• B, G models

Main Circuit Board (9)

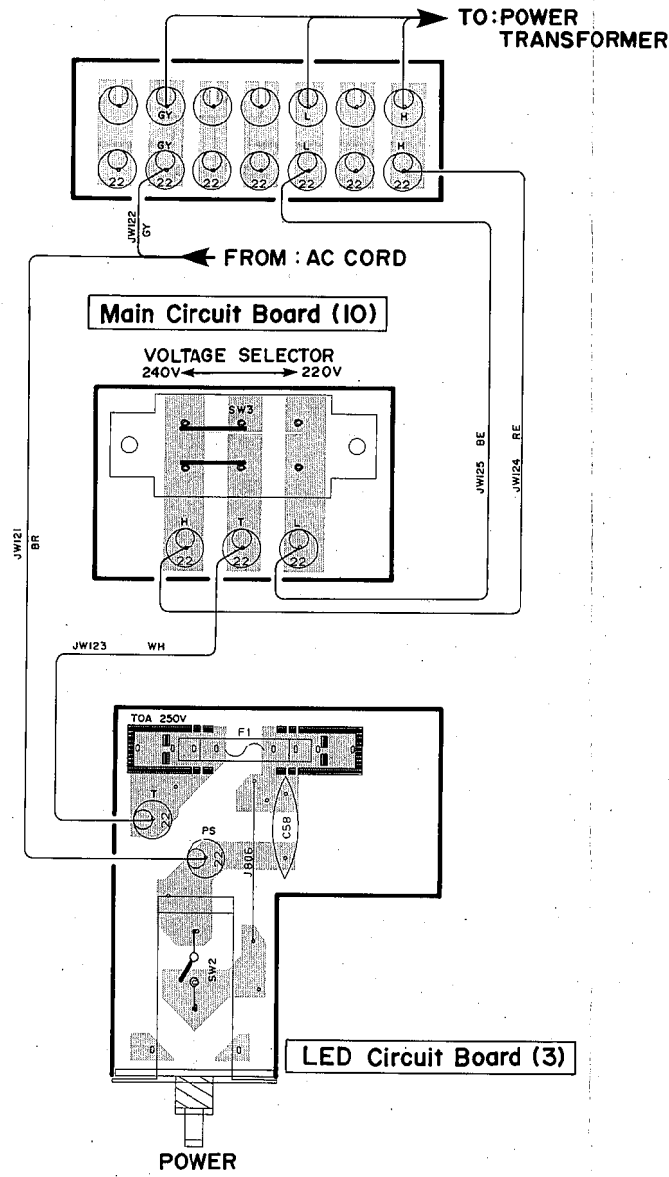

• R model

Main Circuit Board (9)

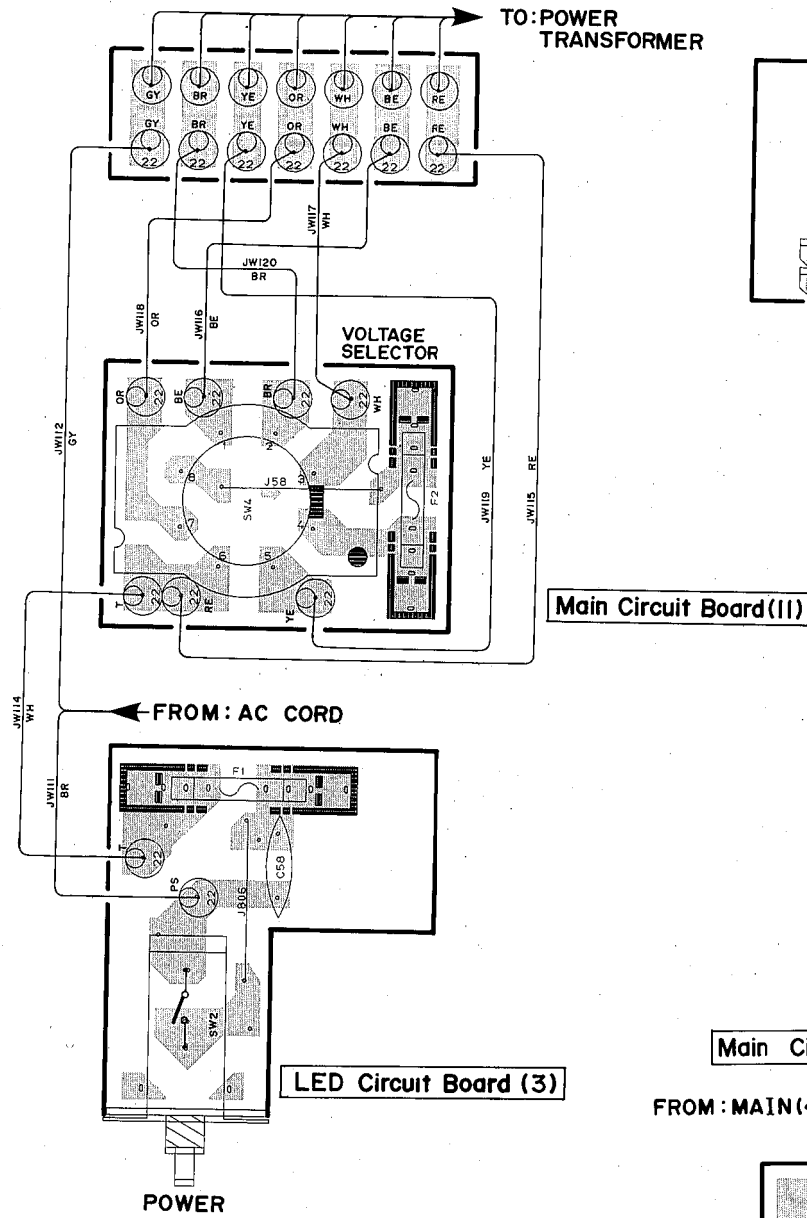

LED Circuit Board (1)

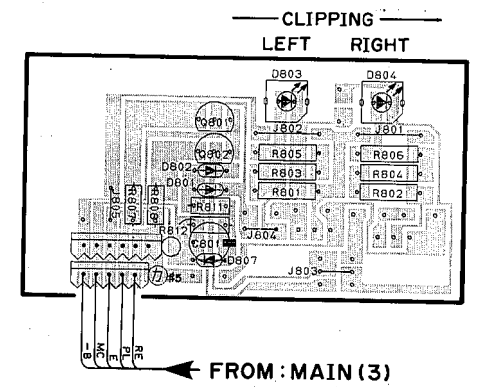

Main Circuit Board (4)

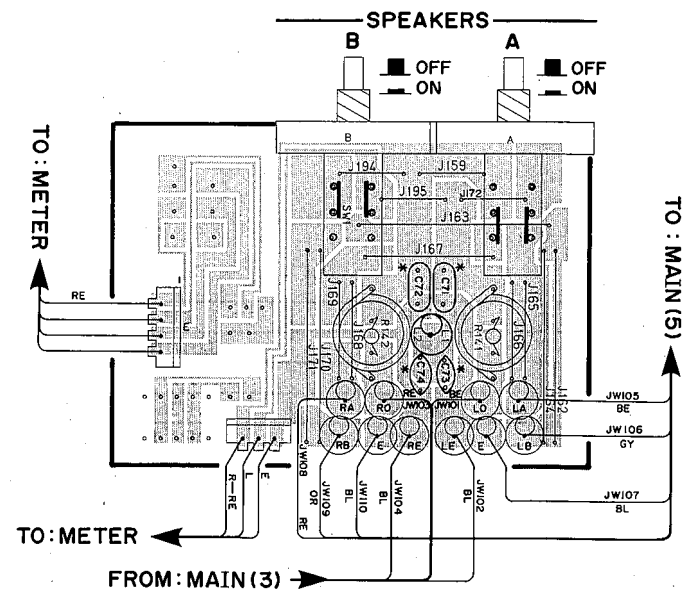

Main Circuit Board (5)

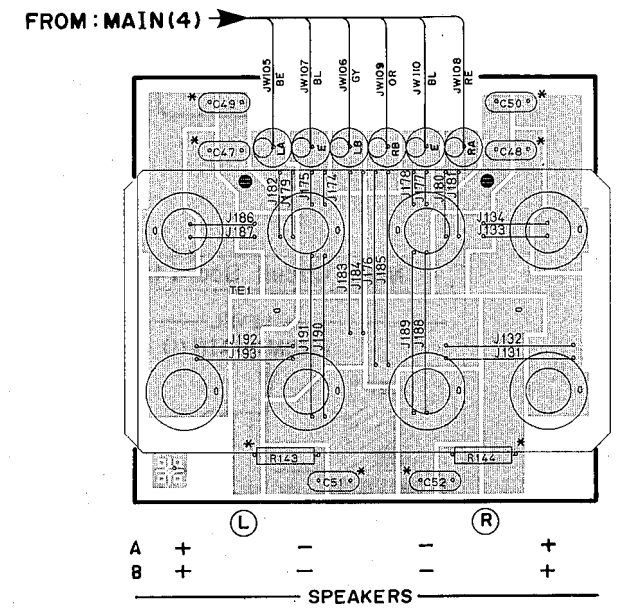

Main Circuit Board (8)

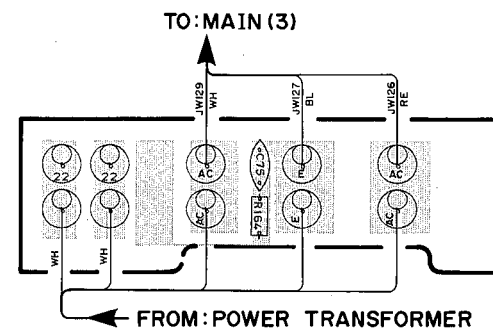

SCHEMATIC DIAGRAM

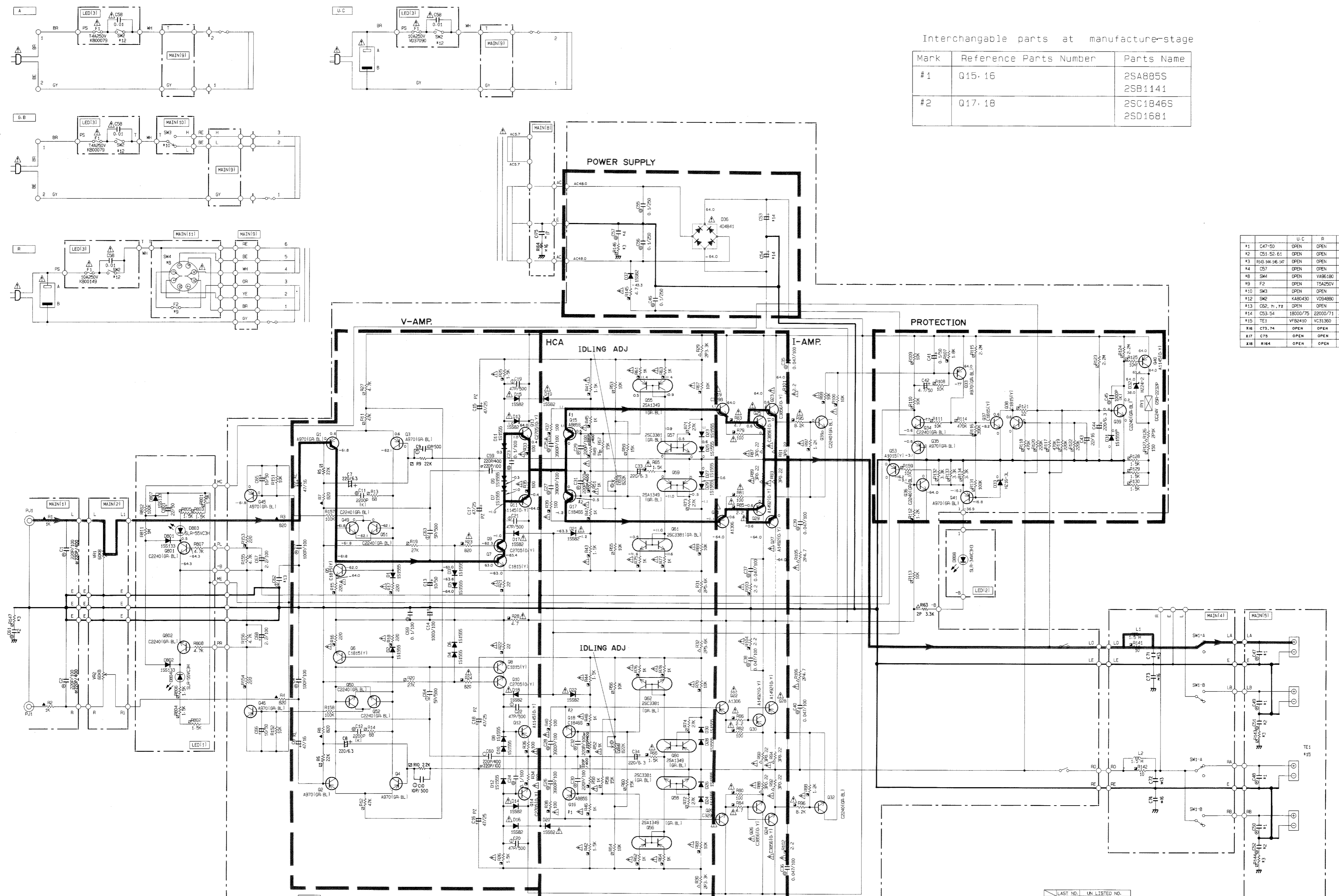

Interchangeable parts at manufacture-stage

Mark	Reference Parts Number	Parts Name
#1	Q15, 16	2SA885S 2SB1141
#2	Q17, 18	2SC1846S 2SD1681

	U.C	R	A	B.G
#1	C47-50	OPEN	OPEN	0.01/100
#2	C51 52-61	OPEN	OPEN	0.01
#3	R13 R14 R16-147	OPEN	OPEN	10
#4	C57	OPEN	OPEN	0.1/250
#5	SM4	OPEN	V48E180	OPEN
#6	F2	OPEN	15A250V	OPEN
#7	SM3	OPEN	OPEN	V69E250
#8	SM2	V48E430	V09-880	V47E540
#9	C62 71, 72	OPEN	OPEN	R4000/100
#10	C53-54	18000/75	22000/71	22000/71
#11	TE1	VF82410	VC31360	VC72080
#12	C73, 74	OPEN	OPEN	100P
#13	C75	OPEN	OPEN	0.1
#14	R164	OPEN	OPEN	2.2

PIN CONNECTION DIAGRAM OF TRANSISTORS, DIODES AND ICs.

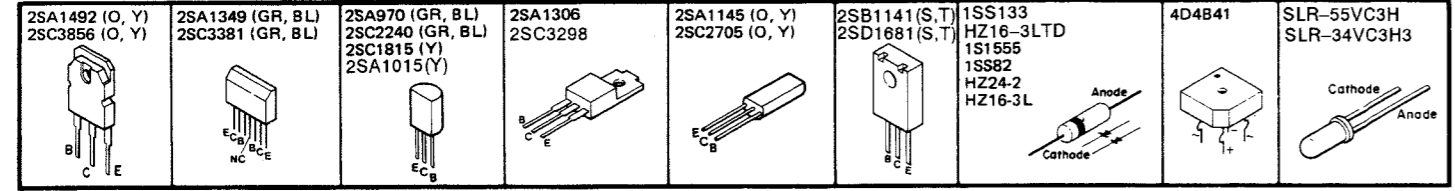

* All voltages are measured with a 10MΩ/DC electric volt meter.
 * Components having special characteristics are marked with a triangle and must be replaced with parts having specifications equal to those originally installed.
 * Schematic diagram is subject to change without notice.

NOTICE
 (U)..... U.S.A model
 (C)..... Canadian model
 (A)..... Australian model
 (G)..... European model
 (B)..... British model
 (R)..... General model
 (P)..... RP model

REMARKS	PARTS NAME
NO MARK	ELECTROLYTIC CAPACITOR
NO MARK	TANTALUM CAPACITOR
NO MARK	CERAMIC CAPACITOR
NO MARK	POLYESTER FILM CAPACITOR
○	POLYSTYRENE FILM CAPACITOR
○	MICA CAPACITOR
○	POLYPROPYLENE FILM CAPACITOR
●	SEMICONDUCTIVE CERAMIC CAPACITOR

LAST NO.	LN LISTED NO.
C 69	
R 162	
D 62	
D 37	
IC	

REMARKS	PARTS NAME
NO MARK	CARBON FILM RESISTOR (1/6W)
□	CARBON FILM RESISTOR (1/4W)
△	METAL OXIDE FILM RESISTOR
△	METAL FILM RESISTOR
□	METAL PLATE RESISTOR
□	FIRE PROOF CARBON FILM RESISTOR
□	CEMENT MOLDED RESISTOR
□	SEMI VARIABLE RESISTOR
■	CHIP RESISTOR

PARTS LIST

■WARNING

Components having special characteristics are marked \triangle and must be replaced with parts having specifications equal to those originally installed.

MX-630

■ ELECTRICAL PARTS

• Carbon resistors (1/6W or 1/4W) are not included in the ELECTRICAL PARTS list. For the parts No. of the carbon resistor, refer to p. 17.

Ref. NO.	PART NO.	Description			部 品 名	Remarks	Markets	注
	V1562300	MAIN CIRCUIT BOARD			メイン シート		U, C	
	V1562400	MAIN CIRCUIT BOARD			メイン シート		R	
	V1562500	MAIN CIRCUIT BOARD			メイン シート		A	
	V1562600	MAIN CIRCUIT BOARD			メイン シート		B, G	
	FC363100	MYLAR FILM CAP	1000pF	50V	マイラーコン	C45		
	FC343220	MYLAR FILM CAP	2200pF	50V	マイラーコン	C11, 12		
	FC344100	MYLAR FILM CAP	0.01 μ F	50V	マイラーコン	C51, 52, 61	G, B	
	UT452220	POLYPROPYLENE FILM CAP	220pF	100V	PPコン	C59, 60		
	FZ004660	MYLAR FILM CAP	0.1 μ F	250V	マイラーコン	C46, 55, 56		
	FZ004660	MYLAR FILM CAP	0.1 μ F	250V	マイラーコン	C57	B, G	
	UT452100	POLYPROPYLENE FILM CAP	100pF	100V	PPコン	C3, 4		
	UT452220	POLYPROPYLENE FILM CAP	220pF	100V	PPコン	C1, 2, 29-32		
	UT454100	POLYPROPYLENE FILM CAP	0.01 μ F	100V	PPコン	C47-50	B, G	
	UH066470	ELECTROLYTIC CAP	4.7 μ F	50V	ケミコン	C42		
	UJ167100	ELECTROLYTIC CAP	10 μ F	50V	ケミコン	C65, 66		
	UJ165100	ELECTROLYTIC CAP	0.1 μ F	50V	ケミコン	C41		
	V1531400	ELECTROLYTIC CAP	220 μ F	6.3V	ケミコン	C7, 8, 33, 34, 44		
	V1532600	ELECTROLYTIC CAP	22 μ F	16V	ケミコン	C43		
	V1912600	ELECTROLYTIC CAP	47 μ F	16V	ケミコン	C5, 6		
	VH620800	ELECTROLYTIC CAP	47 μ F	25V	ケミコン	C15-18		
	VE742700	ELECTROLYTIC CAP	10 μ F	50V	ケミコン	C13		
	VE021700	ELECTROLYTIC CAP	2.2 μ F	100V	ケミコン	C67, 68		
	V1531200	ELECTROLYTIC CAP	1000 μ F	100V	ケミコン	C14		
	FU350500	MICA CAP	5pF	500V	マイカコン	C63, 64		
	FU351100	MICA CAP	10pF	500V	マイカコン	C9, 10		
	UT453100	POLYPROPYLENE FILM CAP	1000pF	100V	PPコン	C82, 71, 72	B, G	
	FG212100	CERAMIC CAP	100pF	50V	セラコン	C73, 74	B, G	
	FU351470	MICA CAP	47pF	500V	マイカコン	C19-22		
	V1861500	POLYPROPYLENE FILM CAP	3900pF	100V	メタライズドポリコン	C25-28		
	V1862100	POLYPROPYLENE FILM CAP	0.047 μ F	100V	メタライズドポリコン	C35-40		
	V1862200	POLYPROPYLENE FILM CAP	0.1 μ F	100V	メタライズドポリコン	C23, 24, 69		
	VC793700	COIL	RZ-001		空芯コイル	L1, 2		
	HV453220	FLAME PROOF CARBON RESISTOR	2.2 Ω	1/4W	不燃化カーボン抵抗	R85, 86, 101-104		\triangle
	HV453470	FLAME PROOF CARBON RESISTOR	4.7 Ω	1/4W	不燃化カーボン抵抗	R28, 83, 84, 145		\triangle
	HV454100	FLAME PROOF CARBON RESISTOR	10 Ω	1/4W	不燃化カーボン抵抗	R141, 142		\triangle
	HV454220	FLAME PROOF CARBON RESISTOR	22 Ω	1/4W	不燃化カーボン抵抗	R21, 22		\triangle
	HV455100	FLAME PROOF CARBON RESISTOR	100 Ω	1/4W	不燃化カーボン抵抗	R33-40, 79-82		\triangle
	HV455220	FLAME PROOF CARBON RESISTOR	220 Ω	1/4W	不燃化カーボン抵抗	R153, 154		\triangle
	HV455820	FLAME PROOF CARBON RESISTOR	820 Ω	1/4W	不燃化カーボン抵抗	R23, 24		\triangle
	HV456100	FLAME PROOF CARBON RESISTOR	1K Ω	1/4W	不燃化カーボン抵抗	R45-52, 61-64, 75-78		\triangle
	HV456120	FLAME PROOF CARBON RESISTOR	1.2K Ω	1/4W	不燃化カーボン抵抗	R97, 98, 112		\triangle
	HV456150	FLAME PROOF CARBON RESISTOR	1.5K Ω	1/4W	不燃化カーボン抵抗	R41-44, 65, 66		\triangle
	HV456180	FLAME PROOF CARBON RESISTOR	1.8K Ω	1/4W	不燃化カーボン抵抗	R107		\triangle
	HV456820	FLAME PROOF CARBON RESISTOR	8.2K Ω	1/4W	不燃化カーボン抵抗	R95, 96		\triangle
	HV457100	FLAME PROOF CARBON RESISTOR	10K Ω	1/4W	不燃化カーボン抵抗	R67-70, 99, 100		\triangle
	HV455220	FLAME PROOF CARBON RESISTOR	220 Ω	1/4W	不燃化カーボン抵抗	R15-18		\triangle
	HV456150	FLAME PROOF CARBON RESISTOR	1.5K Ω	1/4W	不燃化カーボン抵抗	R25, 26		\triangle
	HL323470	METAL OXIDE RESISTOR	4.7 Ω	2W	酸化金属被膜抵抗	R105, 106		\triangle
	HL326100	METAL OXIDE RESISTOR	1K Ω	2W	酸化金属被膜抵抗	R126		\triangle
	HL326330	METAL OXIDE RESISTOR	3.3K Ω	2W	酸化金属被膜抵抗	R29, 30, 163		\triangle

* : New Parts (新規部品)

ランク : Japan only

Ref. NO.	PART NO.	Description	部 品 名		Remarks	Markets	ランク
	HL326560	METAL OXIDE RESISTOR	5.6K Ω	2W	酸化金属被膜抵抗	R31,32	
	HL932220	METAL OXIDE RESISTOR	0.22 Ω	3W	酸化金属被膜抵抗	R87-94	⚠
	HU595820	METAL FILM RESISTOR	820 Ω	1/4W	金属被膜抵抗	R3,4,7,8	
	HU596100	METAL FILM RESISTOR	1K Ω	1/4W	金属被膜抵抗	R1,2	
	VE962600	SLIDE SWITCH	SDKGA4		スライドSW	SW3	B,G
	VA961800	VOLTAGE SELECTOR	ESE-37247-F		電圧切替器	SW4	R
	Vi617300	PUSH SWITCH	SPUF21133A		プッシュSW	SW1	
	KB000400	FUSE	5A	250V	ヒューズ	F2	R
	VC278600	RELAY	DC G5R-2232P		リレー	RY1	
	VF824100	SPEAKER TERMINAL	LTS0810		スピーカターミナル	TE1	U,C
	VC313600	SPEAKER TERMINAL	LTS0810-1001		スピーカターミナル	TE1	R,A
	VC720800	SPEAKER TERMINAL	LTS0810-1001		スピーカターミナル	TE1	B,G
	VE642400	PIN JACK	T5855-AAAE		ピンジャック	PJ1	
	VA725500	HOLDER	5P	TE	パラレルホルダ	CB1-4	
	VD004500	BASE PIN	PH	2P TE	ベースピン	CB9	
	VD004800	BASE PIN	PH	5P TE	ベースピン	CB10	
	VB861600	PRE-SET POTENTIOMETER	B22K		半固定VR	VR3,4	
	VE642500	POTENTIOMETER	B60K		ロータリーVR	VR1,2	
	iA097020	TRANSISTOR	2SA970 GR		トランジスタ	Q1-4,33,35,41,45,46	
	iA101521	TRANSISTOR	2SA1015 Y		トランジスタ	Q53	
	VE198700	TRANSISTOR	2SA1145 O,Y		トランジスタ	Q11,12,40	
	iA130640	TRANSISTOR	2SA1306 LB O,Y		トランジスタ	Q21,22	⚠
	iC224020	TRANSISTOR	2SC2240 GR		トランジスタ	Q31,32,34,36,39,49-52	
	iC1815C0	TRANSISTOR	2SC1815 Y		トランジスタ	Q5-8,37,38	
	VE198800	TRANSISTOR	2SC2705 O,Y		トランジスタ	Q9,10,13,14	
	iC329840	TRANSISTOR	2SC3298		トランジスタ	Q19,20	⚠
	iA134900	TRANSISTOR	2SA1349		トランジスタ	Q55,56,59,60	
	iC338100	TRANSISTOR	2SC3381 GR,BL		トランジスタ	Q57,58,61,62	
	iF000040	DIODE	1S1555		ダイオード	D1-12,23-31	
	iF005560	DIODE	1SS82TD		ダイオード	D13-22,37	⚠
	iH001160	DIODE BRIDGE	4D4B41	4A 200V	D I スタック	D36	⚠
	iF003540	ZENER DIODE	HZ16-3LTD		ツェナーダイオード	D33	
	iF001940	ZENER DIODE	HZ24-2	24V	ツェナーダイオード	D32	
	LB201970	FUSE HOLDER PIN			ヒューズホルダーピン		R
	VA821500	RADIATOR			ラジエター		
	BB069510	GROUND PLATE	#6951		ランド金具		
	EZ001350	CUP B-TYTE SCREW	3x14	FCM3-BL	カップBタイトネジ		
*	Vi585300	LED CIRCUIT BOARD			LED シート		U,C
*	Vi665400	LED CIRCUIT BOARD			LED シート		R
*	Vi665500	LED CIRCUIT BOARD			LED シート		A,B,G
	U1367220	ELECTROLYTIC CAP	22 μ F	50V	ケミコン	C801	
	F1414100	CERAMIC CAP	0.01 μ F		スパークキラーコン	C58	⚠
	KA804300	PUSH SWITCH	ESB-99753V		プッシュSW	SW2	U,C
	VD948800	PUSH SWITCH	ESB-82106V-F		プッシュSW	SW2	R
	VA726400	PUSH SWITCH	ESB-8293V-F		プッシュSW	SW2	A,G,B
	VD370900	FUSE	10A		ヒューズ	F1	U,C
	KB001490	FUSE	10A	250V	ヒューズ	F1	R

EXPLODED VIEW

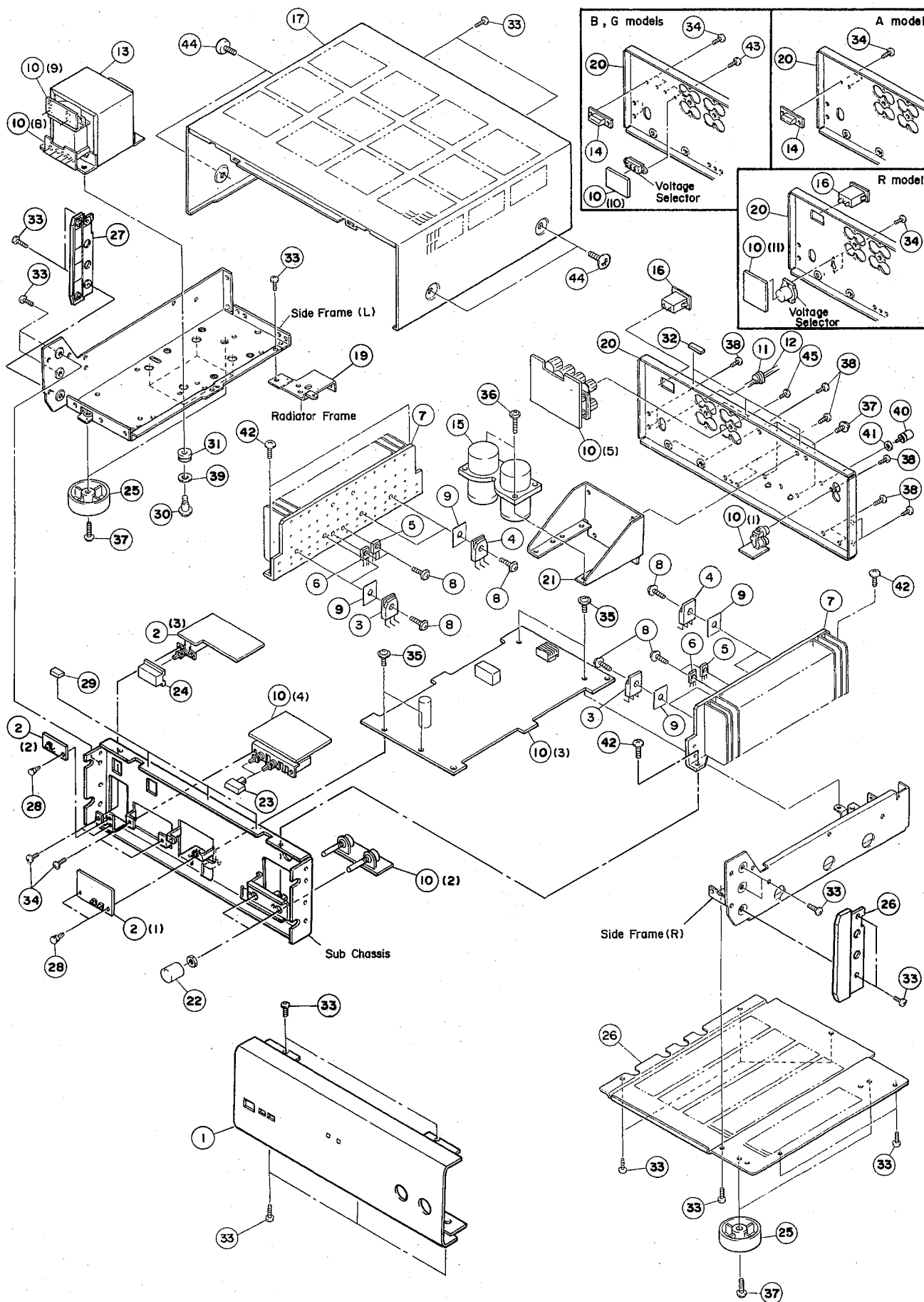

Ref. NO.	PART NO.	Description	部 品 名	Remarks	Markets	ランク
01	Vi561900	PANEL UNIT		パネルユニット	BL	
01	Vi562000	PANEL UNIT		パネルユニット	T	
02	Vi585300	LED CIRCUIT BOARD		LED シート		U,C
02	Vi665400	LED CIRCUIT BOARD		LED シート		R
02	Vi665500	LED CIRCUIT BOARD		LED シート		A,B,G
03	iX609750	TRANSISTOR	2SA1492 O,Y	トランジスタ	Q27-30	
04	iX609760	TRANSISTOR	2SC3856 O,Y	トランジスタ	Q23-26	
05	VE912800	TRANSISTOR	2SB1141 S,T	トランジスタ	Q15,16	
06	VE912900	TRANSISTOR	2SD1681 S,T	トランジスタ	Q17,18	
07	BA094300	RADIATOR		放熱板		
08	EZ001350	CUP B-TYTE SCREW	3x14 FCM3-BL	カップBタイトネジ		
09	VB435000	SHEET	TD-3P	放熱シート		
10	Vi562300	MAIN CIRCUIT BOARD		メイン シート		U,C
10	Vi562400	MAIN CIRCUIT BOARD		メイン シート		R
10	Vi562500	MAIN CIRCUIT BOARD		メイン シート		A
10	Vi562600	MAIN CIRCUIT BOARD		メイン シート		B,G
11	CB620200	CORD STOPPER	CM-22C	コードストッパー		U,C
11	CB620190	CORD STOPPER	CM-22B	コードストッパー		R,A
11	CB072750	CORD STOPPER	SR-4N-4	コードストッパー		B,G
12	MG002220	POWER CORD	10A SPT-2	電源コード		U,C
12	VE371000	POWER CORD	6A 2M	電源コード		R
12	MG002310	POWER CORD	7.5A	電源コード		A
12	Vi616000	POWER CORD	6A 2M	電源コード		B
12	MG000910	POWER CORD	6A H05VVH2	電源コード		G
13	XE217001	POWER TRANSFORMER		電源トランス		U
13	XE218001	POWER TRANSFORMER		電源トランス		C
13	XE219001	POWER TRANSFORMER		電源トランス		R
13	XE220001	POWER TRANSFORMER		電源トランス		A
13	XE221001	POWER TRANSFORMER		電源トランス		B,G
14	VD614100	TERMINAL	ST8VP-B	中継端子台		A,B,G
15	Vi615600	ELECTROLYTIC CAP	18000 μF 75V	ケミコンセット		U,C
15	Vi615700	ELECTROLYTIC CAP	22000 μF 71V	ケミコンセット		R,A,B,G
16	LB203060	AC OUTLET	S-16519	ACアウトレット		U,C,R
17	Vi721800	TOP COVER		トップカバー	BL	
17	Vi200600	TOP COVER		トップカバー	T	
18	AA622030	BOTTOM COVER		ボトムカバー		
19	AA622040	STAY,HEAT SINK		ヒートシンクステー		
20	Vi200800	REAR PANEL		リヤパネル		U,C
20	Vi200700	REAR PANEL		リヤパネル		R
20	Vi200900	REAR PANEL		リヤパネル		A
20	Vi201000	REAR PANEL		リヤパネル		B,G
21	AA623350	CAPACITOR ANGLE		ケミコン金具		
22	VH889200	KNOB		ノブ	BL	
22	VH889300	KNOB		ノブ	T	
23	VH816000	BUTTON	3/14	ボタン	BL	
23	VH816100	BUTTON	3/14	ボタン	T	
24	VH841900	BUTTON	10/25	ボタン	BL	
24	VH842000	BUTTON	10/25	ボタン	T	
25	CB660950	LEG		レッグ	BL	
25	Vi175700	LEG		レッグ	T	

※ : New Parts (新規部品)

ランク : Japan only



MX-630

Ref. NO.	PART NO.	Description	部 品 名		Remarks	Markets	ランク
26	Vi201500	SIDE COVER R			サイドカバー R	BL	
26	Vi201600	SIDE COVER R			サイドカバー R	T	
27	Vi320000	SIDE COVER L			サイドカバー L	BL	
27	Vi320100	SIDE COVER L			サイドカバー L	T	
28	CB068880	PLASTIC RIVET	#1027		ブラリベット		
* 29	VJ113900	DAMPER			ダンパー		
30	AA603850	SCREW			段付ネジ		
31	CB099910	RUBBER, CUSHION			防振ゴム		
32	VF588300	DAMPER			ダンパー		
33	Ei330086	BINDING HEAD TAPPING SCREW	3x8	FCRM3-BL	バインドタッピングネジ		
34	ED330066	BINDING HEAD SCREW	3x6	FCRM3-BL	バインド小ネジ		
35	EK336010	BW HEAD TAPPING SCREW	3x8-10	FCM3-BL	BWヘッドタッピングネジ		
36	EK330050	BW HEAD TAPPING SCREW	3x18	FCM3-BL	BWヘッドタッピングネジ		
37	EK930010	BW HEAD TAPPING SCREW	3x8-8	FCRM3-BL	BWヘッドタッピングネジ		
38	EZ000460	BIND HEAD BONDING TAP. SCREW	3x8	FCM3-BL	ボンディングBタイトネジ		
39	EV220600	PLAIN WASHER	6x13x1	FCM3-BL	平座金みがき丸		
40	AA627310	GROUND TERMINAL	#7239		GNDターミナル		
41	EV901360	PLAIN WASHER	3.6x10x0.8	FNM3-3G	平座金みがき丸		
42	Ei340086	BINDING HEAD TAPPING SCREW	4x8	FCRM3-BL	バインドBタイトネジ		
43	EA326086	PAN HEAD SCREW	2.6x8	FCM3-BL	鉄ナベPタイト	B,G	
44	EK365190	BW HEAD B-TYTE SCREW	4x8-10	FNM3-BL	BWヘッドBタイトネジ	T	
44	EK966070	BW HEAD TAPPING SCREW	4x8	ZMC2-BL	BWHBタイト	BL	
45	EK600010	BIND HEAD BONDING TAP. SCREW	3x10	FCRM3-3G	ボンディングBタイトネジ		
46	CB069250	BINDING TIE	BK-1		束線止め		
47	EK335010	BW HEAD TAPPING SCREW	3x6	FCM3-BL	BWヘッドタッピングネジ		

Parts List for Carbon Resistors

Value	1/4W Type Part No.	1/6W Type Part No.	Value	1/4W Type Part No.	1/6W Type Part No.
1.0 Ω	HJ353100	HF853100	12KΩ	HJ357120	HF857120
1.8 "	HJ353180	*	15 "	HJ357150	HF857150
2.2 "	HJ353220	HF853220	18 "	HJ357180	HF857180
3.3 "	HJ353330	HF853330	22 "	HJ357220	HF857220
4.7 "	HJ353470	HF853470	27 "	HJ357270	HF857270
5.6 "	HJ353560	HF853560	33 "	HJ357330	HF857330
10 "	HJ354100	HF854100	39 "	HJ357390	HF857390
15 "	HJ354150	HF854150	47 "	HJ357470	HF857470
22 "	HJ354220	HF854220	56 "	HJ357560	HF857560
27 "	HJ354270	HF854270	68 "	HJ357680	HF857680
33 "	HJ354330	HF854330	82 "	HJ357820	HF857820
39 "	HJ354390	HF854390	91 "	HJ357910	HF857910
47 "	HJ354470	HF854470	100 "	HJ358100	HF858100
56 "	HJ354560	HF854560	120 "	HJ358120	HF858120
68 "	HJ354680	HF854680	150 "	HJ358150	HF858150
82 "	HJ354820	HF854820	180 "	HJ358180	HF858180
100 "	HJ355100	HF855100	220 "	HJ358220	HF858220
110 "	HJ355110	HF855110	270 "	HJ358270	HF858270
120 "	HJ355120	HF855120	330 "	HJ358330	HF858330
150 "	HJ355150	HF855150	390 "	HJ358390	HF858390
160 "	HJ355160	*	470 "	HJ358470	HF858470
180 "	HJ355180	HF855180	560 "	HJ358560	HF858560
220 "	HJ355220	HF855220	680 "	HJ358680	HF858680
270 "	HJ355270	HF855270	820 "	HJ358820	HF858820
330 "	HJ355330	HF855330	1.0MΩ	HJ359100	HF859100
390 "	HJ355390	HF855390	1.2 "	HJ359120	*
470 "	HJ355470	HF855470	1.5 "	HJ359150	HF859150
510 "	*	HF855510	1.8 "	HJ359180	HF859180
560 "	HJ355560	HF855560	2.2 "	HJ359220	HF859220
680 "	HJ355680	HF855680	3.3 "	HJ359330	HF859330
820 "	HJ355820	HF855820	3.9 "	HJ359390	*
910 "	HJ355910	HF855910	4.7 "	HJ359470	HF859470
1.0KΩ	HJ356100	HF856100			
1.2 "	HJ356120	HF856120			
1.5 "	HJ356150	HF856150			
1.8 "	HJ356180	HF856180			
2.0 "	HJ356200	HF856200			
2.2 "	HJ356220	HF856220			
2.4 "	HJ356240	HF856240			
2.7 "	HJ356270	HF856270			
3.0 "	HJ356300	HF856300			
3.3 "	HJ356330	HF856330			
3.6 "	HJ356360	HF856360			
3.9 "	HJ356390	HF856390			
4.7 "	HJ356470	HF856470			
5.1 "	HJ356510	HF856510			
5.6 "	HJ356560	HF856560			
6.8 "	HJ356680	HF856680			
8.2 "	HJ356820	HF856820			
9.1 "	HJ356910	HF856910			
10 "	HJ357100	HF857100			

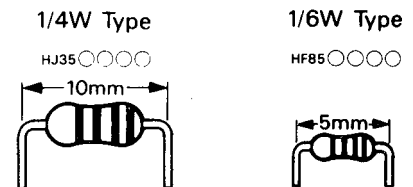

MX-630

MX-630

YAMAHA